

# eMobile Charging sockets





## Over half a century competence and experience

Bals is a quality brand for innovation, reliability and service worldwide. For more than 65 years we have been producing connectors for the world market, and we are known for the highest quality "Made in Germany".

In our plants a team of highly qualified and motivated colleagues is manufacturing in an uncompromised quality approach multiple

thousand state-of-the-art devices per day. With an extraordinary high production depth we are covering the areas of product design and development, contact manufacturing, tooling, injection moulding, assembly and quality control. From the first idea to the final product, all this takes place in-house, to ensure constant supply chain and limiting the carbon footprint.



## Three modern factories one consistent quality standard

From the beginning the headquarters of our company is located in Kirchhundem-Albaum (North-Rhine-Westphalia). Product development, marketing and sales, as well as administration are located here. In addition, plug and socket systems and special products are manufactured in the Kirchhundem-Albaum factory. The factory in Freiwalde (Brandenburg), has state-of-the-art production facilities for fully-automatic manufacturing of unique CEE plugs and connectors as well as a highly-effective logistics centre. Bals is active since decades in the manufacturing of components for the electric vehicle charging infrastructure. From 2021 in a dedicated new factory in Kirchhundem-Würdinghausen.



## Future solutions for global markets

The proximity and partnership with our customers has guided our products in over 80 countries around the world. We are active participants of standardisation procedure on international and national area and commit with input into the legislation works of compliance topics on multiple stakeholder levels. We remain at the pulse of time, and challenge future topic well in advance, to ensure product compliance not only to today's requirements, but also future standards.



## Customer proximity: You can rely on us

Always close to the customers. For us, this is no empty phrase but reality. Flexibility, customer orientation and the ability to quickly respond to short-term requirements are a matter of course for us. For this reason, integrated production - from the product idea and design to tool making and production to the shipment of the products - is optimised for short processing paths and the fastest response times.



## People make the difference

Over 300 employees, who are dedicated and tightly connected to the company, have only one goal: to satisfy you, our customers, one hundred percent. This applies to the highest of quality stan-

dards that we apply to our product and also for made-to-measure service and personal contact from person to person.



## Our responsibility to the highest quality

Quality does not permit any compromise. Besides having an ISO-9001-certified production process in all factories, we are implementing additional IATF based quality process beyond. Full automated and controlled assembly lines, electrical and mechanical quality control or extended process documentation are only few of them. The products are undergoing additional market driven evaluations in our in-house test laboratory which is under the positive assessment of VDE and ASEFA. We remain proactive on customer needs and validation requests.



## Our responsibility to the environment

We know and love our region. Maintaining and protecting this unique landscape for future generations is important to us. Production that saves as many resources as possible, the highest environmental standards and continual enhancement of our ecological efficiency at all levels are a matter of course for us. Every individual employee at Bals is aware of this responsibility to people and nature.



## Our responsibility to people and the region

As a family-owned company, we are well aware of our special responsibility. We keep jobs safe, encourage the development of every individual and are loyal to our sites which we care for and permanently develop in the long term. Thinking about the future is also important to us: For this reason, we create qualified training positions in a wide variety of professional areas each year. We support numerous local meetings and events and employ an above average number of people with handicaps.

Type 2 charging socket - IP54 - compact design

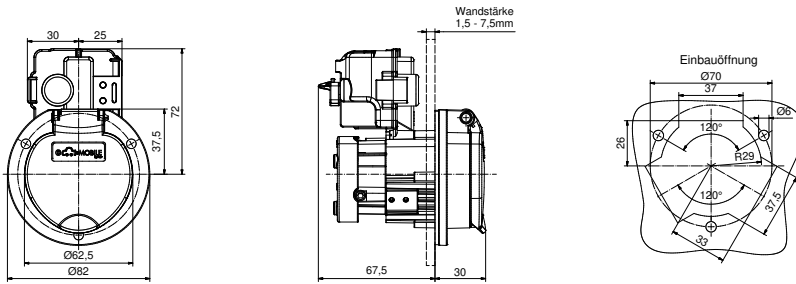
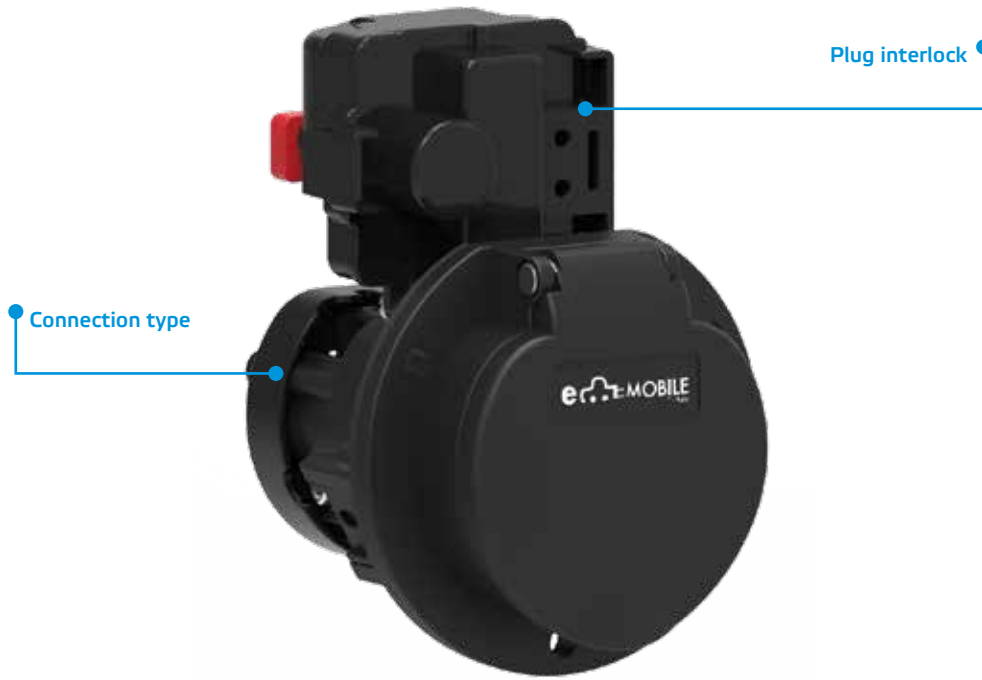

Compact design

Thanks to its very small external dimensions, it can be installed in the smallest of spaces. Available in IP20 and IP54.



Connection type

Up to 63A possible with easy CONTACT screw connection.

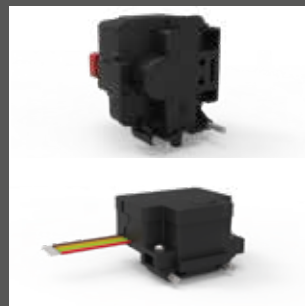

Plug interlock

Three actuator positions according to IEC 62196-2 for the greatest flexibility during installation.

- 3-pole actuator, connection via available connecting cable
- 4-pole actuator with potential-free feedback contact and integrated connecting cables (500mm)

Charging capacity	Protection degree	Actuator plug interlock	Part No.
up to 20A - up to 11kW	IP20	3pol.	E-80201-16
up to 32A - up to 22kW	IP20	3pol.	E-80201-32
up to 20A - up to 11kW	IP54	3pol.	E-80200-16
up to 32A - up to 22kW	IP54	3pol.	E-80200-32
up to 20A - up to 11kW	IP20	4pol.	E-80201-16E
up to 32A - up to 22kW	IP20	4pol.	E-80201-32E
up to 20A - up to 11kW	IP54	4pol.	E-80200-16E
up to 32A - up to 22kW	IP54	4pol.	E-80200-32E



## Type 2 charging socket - IP54 - flange 85x85

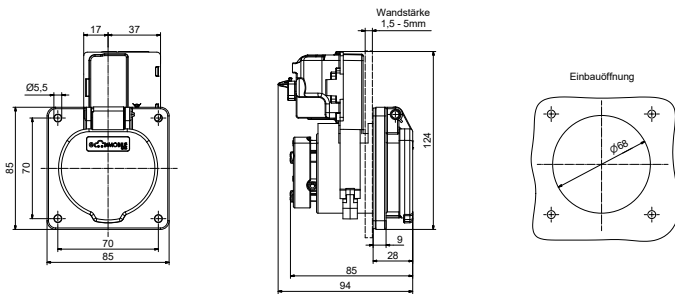

Connection type

Up to 63A possible with easy CONTACT screw connection.



Plug interlock

- 3-pole actuator, connection via available connecting cable



Charging capacity	Protection degree	Actuator plug interlock	Part No.
up to 20A - up to 11kW	IP54	3pol.	E-80190-16
up to 32A - up to 22kW	IP54	3pol.	E-80190-32



Type 2 charging socket - IP54 - Standard

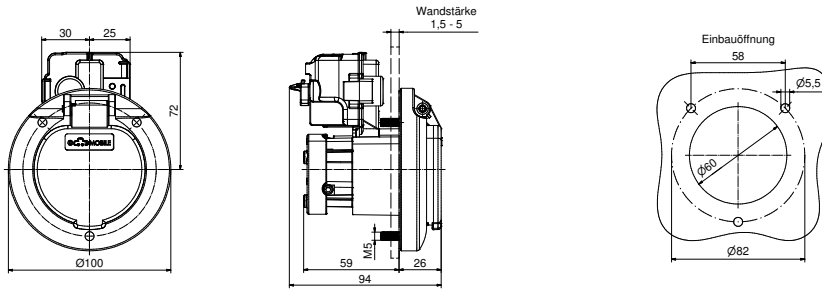
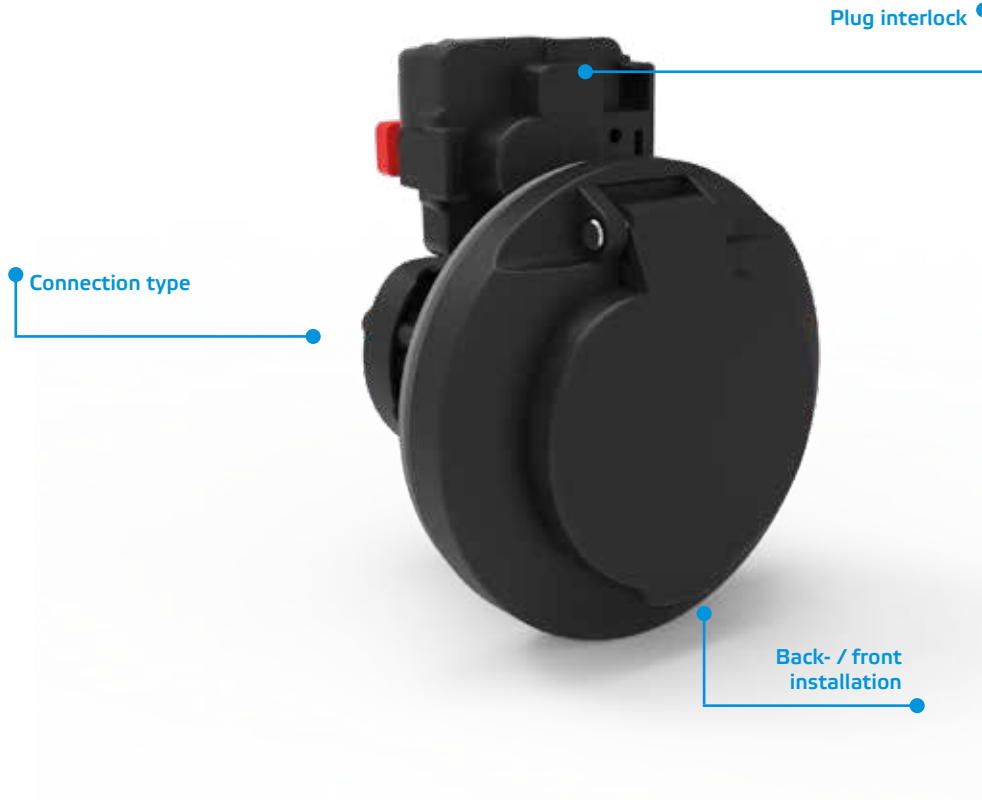

Connection type

Available as an easy CONTACT screw connection or with crimped single wires (700mm) without pre-fabrication as a standard version.



Plug interlock

- 3-pole actuator, connection via available connecting cable
- 4-pole actuator with potential-free feedback contact and integrated connecting cables (500mm)



Confection

Different wire lengths and confection for the crimped version available on request.

Charging capacity	Connection type	Actuator plug interlock	Back- / front installation	Part No.
up to 20A - up to 11kW	Screw connection	3pol.	Front installation	E-81191-16
up to 32A - up to 22kW	Screw connection	3pol.	Front installation	E-81191-32
up to 20A - up to 11kW	Screw connection	3pol.	Back installation	E-811913-16
up to 32A - up to 22kW	Screw connection	3pol.	Rückeinbau	E-811913-32
up to 20A - up to 11kW	crimped single wires 700mm	3pol.	Front installation	E-83191-16A0700A
up to 32A - up to 22kW	crimped single wires 700mm	3pol.	Front installation	E-83191-32A0700A
up to 20A - up to 11kW	crimped single wires 700mm	4pol.	Front installation	E-83191-16E0700A
up to 32A - up to 22kW	crimped single wires 700mm	4pol.	Front installation	E-83191-32E0700A
up to 20A - up to 11kW	crimped single wires 700mm	3pol.	Back installation	E-831913-16A0700A
up to 32A - up to 22kW	crimped single wires 700mm	3pol.	Back installation	E-831913-32A0700A
up to 20A - up to 11kW	crimped single wires 700mm	4pol.	Back installation	E-831913-16E0700A
up to 32A - up to 22kW	crimped single wires 700mm	4pol.	Back installation	E-831913-32E0700A



Type 2 charging socket - IP54 - without LED

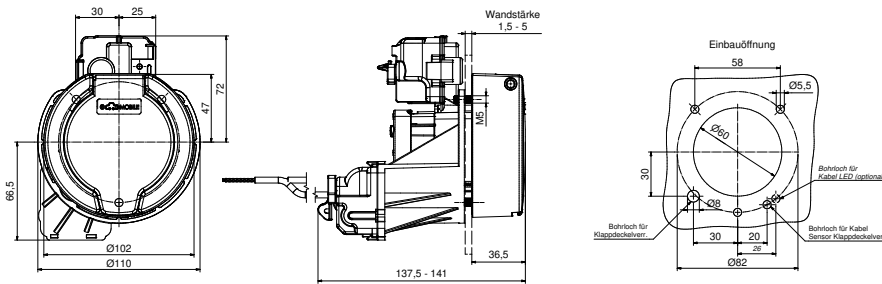
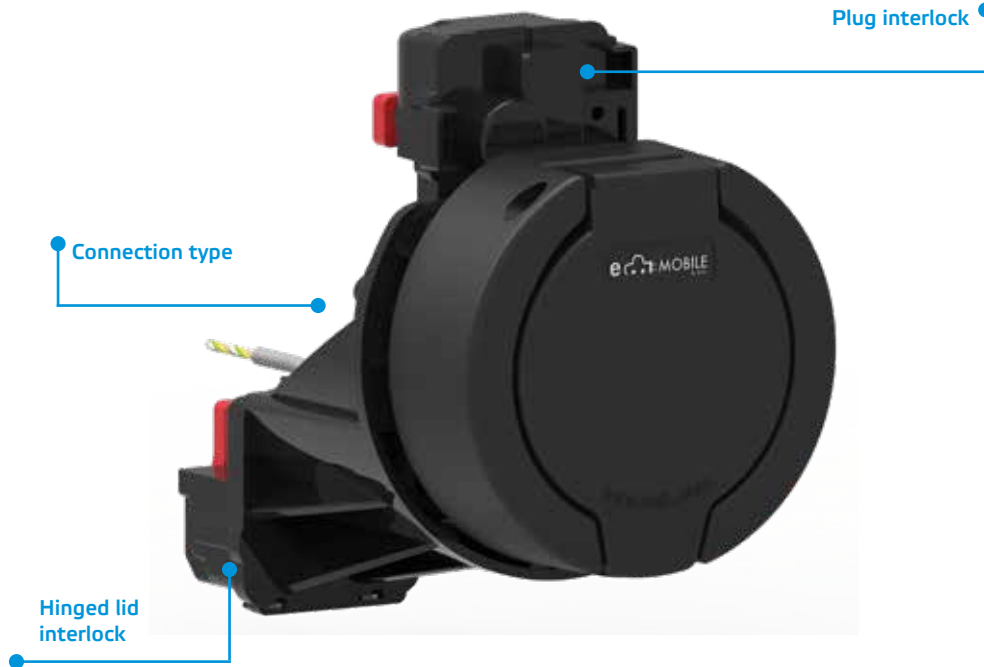

Connection type

Available as an easy CONTACT screw connection or with crimped single wires (700mm) without pre-fabrication as a standard version.



Plug interlock

- 3-pole actuator, connection via available connecting cable
- 4-pole actuator with potential-free feedback contact and integrated connecting cables (500mm)



Hinged lid interlock

Available with or without hinged lid lock.  
The charging socket is protected by the built-in hinged lid interlock, e.g. from access by unauthorized users.



Confection

Different wire lengths and confection for the crimped version available on request.

Charging capacity	Connection type	Actuator plug interlock	Hinged lid interlock	Part No.
up to 20A - up to 11kW	Screw connection	3pol.	<input type="checkbox"/>	E-81194-16
up to 32A - up to 22kW	Screw connection	3pol.	<input type="checkbox"/>	E-81194-32
up to 20A - up to 11kW	Screw connection	3pol.	<input checked="" type="checkbox"/>	E-81192-16
up to 32A - up to 22kW	Screw connection	3pol.	<input checked="" type="checkbox"/>	E-81192-32
up to 20A - up to 11kW	crimped single wires 700mm	3pol.	<input type="checkbox"/>	E-83194-16A0700A
up to 32A - up to 22kW	crimped single wires 700mm	3pol.	<input type="checkbox"/>	E-83194-32A0700A
up to 20A - up to 11kW	crimped single wires 700mm	4pol.	<input type="checkbox"/>	E-83194-16E0700A
up to 32A - up to 22kW	crimped single wires 700mm	4pol.	<input type="checkbox"/>	E-83194-32E0700A
up to 20A - up to 11kW	crimped single wires 700mm	3pol.	<input checked="" type="checkbox"/>	E-83192-16A0700A
up to 32A - up to 22kW	crimped single wires 700mm	3pol.	<input checked="" type="checkbox"/>	E-83192-32A0700A
up to 20A - up to 11kW	crimped single wires 700mm	4pol.	<input checked="" type="checkbox"/>	E-83192-16E0700A
up to 32A - up to 22kW	crimped single wires 700mm	4pol.	<input checked="" type="checkbox"/>	E-83192-32E0700A



Type 2 charging socket - IP54 - with LED

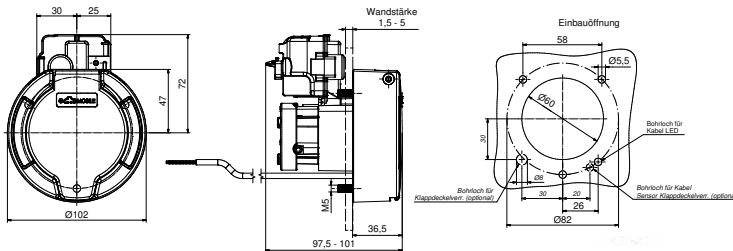
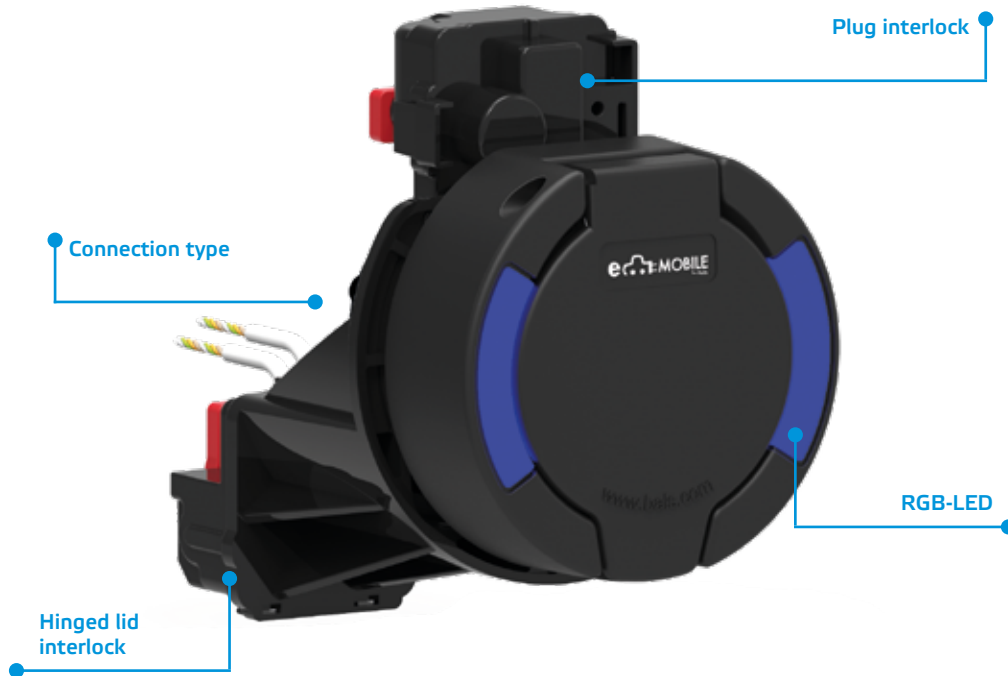

**Connection type**  
Available as an easy CONTACT screw connection or with crimped single wires (700mm) without prefabrication as a standard version.



**Plug interlock**

- 3-pole actuator, connection via available connecting cable
- 4-pole actuator with potential-free feedback contact and integrated connecting cables (500mm)



**Hinged lid interlock**  
Available with or without hinged lid lock.  
The charging socket is protected by the built-in hinged lid interlock, e.g. from access by unauthorized users.

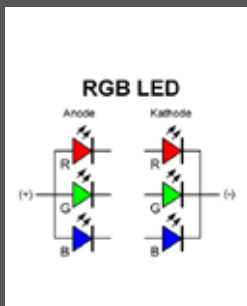

**RGB-LED**  
2x RGB-LED lighting available in two versions:  
- as standard version with common anode (+)  
- on request as version with common cathode (-)



**Confection**  
Different wire lengths and confection for the crimped version available on request.

Charging capacity	Connection type	Actuator plug interlock	Hinged lid interlock	Part No.
up to 20A - up to 11kW	Screw connection	3pol.	<input type="checkbox"/>	E-81195-16
up to 32A - up to 22kW	Screw connection	3pol.	<input type="checkbox"/>	E-81195-32
up to 20A - up to 11kW	Screw connection	3pol.	<input checked="" type="checkbox"/>	E-81193-16
up to 32A - up to 22kW	Screw connection	3pol.	<input checked="" type="checkbox"/>	E-81193-32
up to 20A - up to 11kW	crimped single wires 700mm	3pol.	<input type="checkbox"/>	E-83195-16A0700A
up to 32A - up to 22kW	crimped single wires 700mm	3pol.	<input type="checkbox"/>	E-83195-32A0700A
up to 20A - up to 11kW	crimped single wires 700mm	4pol.	<input type="checkbox"/>	E-83195-16E0700A
up to 32A - up to 22kW	crimped single wires 700mm	4pol.	<input type="checkbox"/>	E-83195-32E0700A
up to 20A - up to 11kW	crimped single wires 700mm	3pol.	<input checked="" type="checkbox"/>	E-83193-16A0700A
up to 32A - up to 22kW	crimped single wires 700mm	3pol.	<input checked="" type="checkbox"/>	E-83193-32A0700A
up to 20A - up to 11kW	crimped single wires 700mm	4pol.	<input checked="" type="checkbox"/>	E-83193-16E0700A
up to 32A - up to 22kW	crimped single wires 700mm	4pol.	<input checked="" type="checkbox"/>	E-83193-32E0700A



## Type 2 charging socket - IP54 - with 4-point attachment

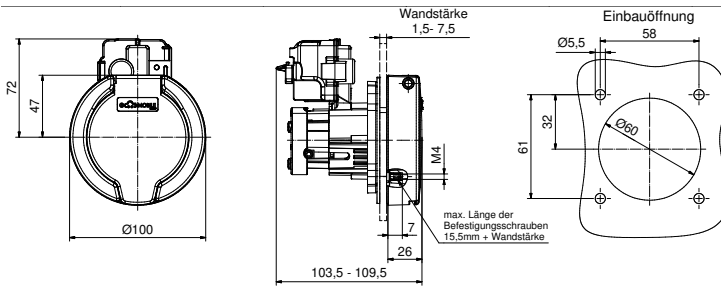

Connection type

Available as an easy CONTACT screw connection or with crimped single wires (700mm) without pre-fabrication as a standard version.

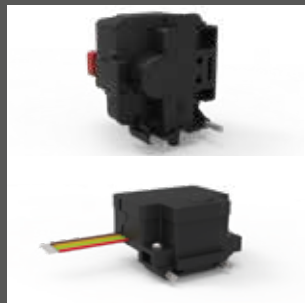

Plug interlock

- 3-pole actuator, connection via available connecting cable
- 4-pole actuator with potential-free feedback contact and integrated connecting cables (500mm)



Confection

Different wire lengths and confection for the crimped version available on request.



Charging capacity	Connection type	Actuator plug interlock	Part No.
up to 20A - up to 11kW	Screw connection	3pol.	E-80205-16
up to 32A - up to 22kW	Screw connection	3pol.	E-80205-32
up to 20A - up to 11kW	crimped single wires 700mm	3pol.	E-83205-16A0700A
up to 32A - up to 22kW	crimped single wires 700mm	3pol.	E-83205-32A0700A
up to 20A - up to 11kW	crimped single wires 700mm	4pol.	E-83205-16E0700A
up to 32A - up to 22kW	crimped single wires 700mm	4pol.	E-83205-32E0700A



Type 2 charging socket - IP54 - with shutter

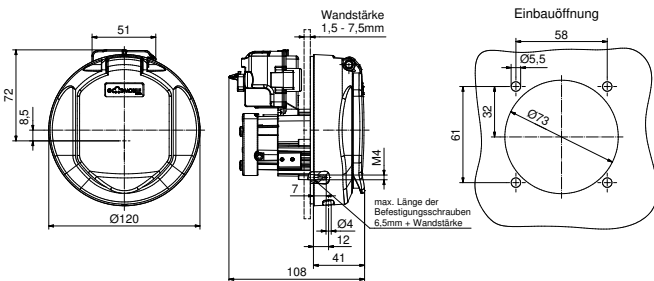
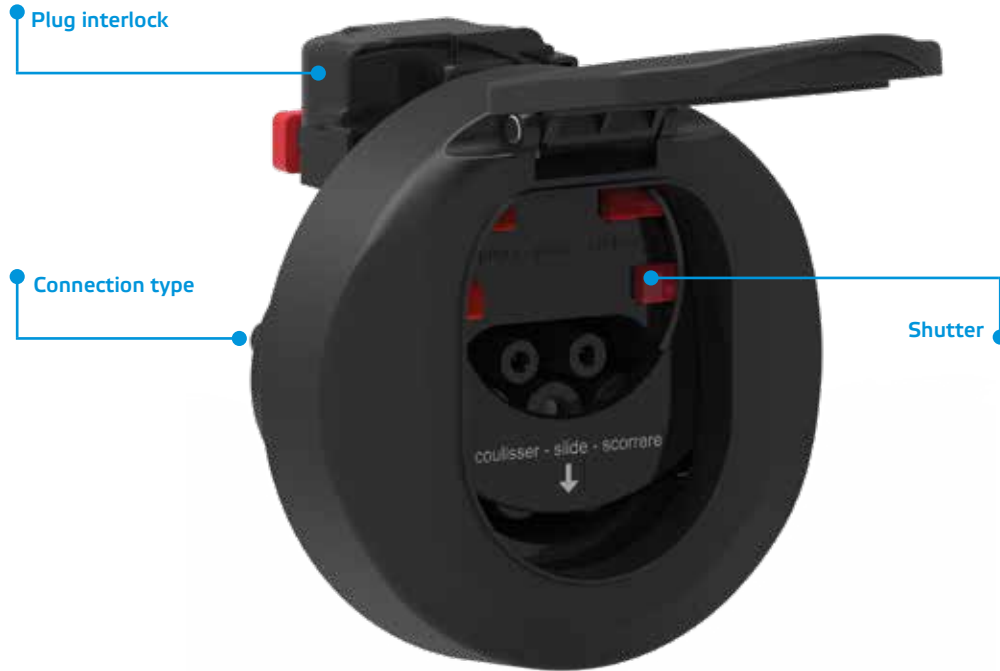

Connection type

Available as an easy CONTACT screw connection or with crimped single wires (700mm) without pre-fabrication as a standard version.

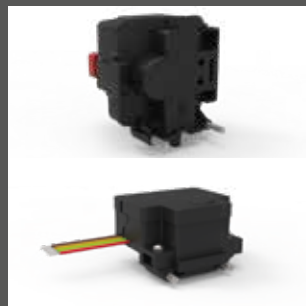

Plug interlock

Three actuator positions according to IEC 62196-2 for the greatest flexibility during installation.

- 3-pole actuator, connection via available connecting cable
- 4-pole actuator with potential-free feedback contact and integrated connecting cables (500mm)



Shutter function

The integrated shutter function guarantees an additional mechanical contact protection of IPXXD, which ensures compliance with the regulations for domestic use in many countries of the European Union as additional protection. Despite the shutter function, one-hand operation is possible.



Confection

Different wire lengths and confection for the crimped version available on request.

Charging capacity	Connection type	Actuator plug interlock	Part No.
up to 20A - up to 11kW	Screw connection	3pol.	E-80300-16
up to 32A - up to 22kW	Screw connection	3pol.	E-80300-32
up to 20A - up to 11kW	crimped single wires 700mm	3pol.	E-83300-16A0700A
up to 32A - up to 22kW	crimped single wires 700mm	3pol.	E-83300-32A0700A
up to 20A - up to 11kW	crimped single wires 700mm	4pol.	E-83300-16E0700A
up to 32A - up to 22kW	crimped single wires 700mm	4pol.	E-83300-32E0700A



Schuko-type charging socket 16A 230V - with type 2 cover

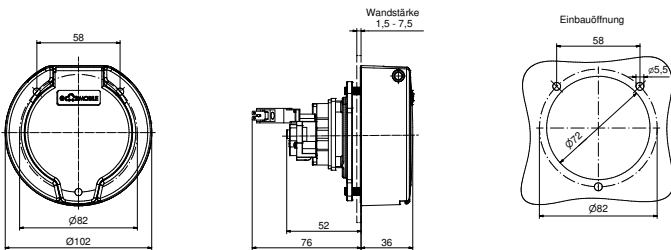
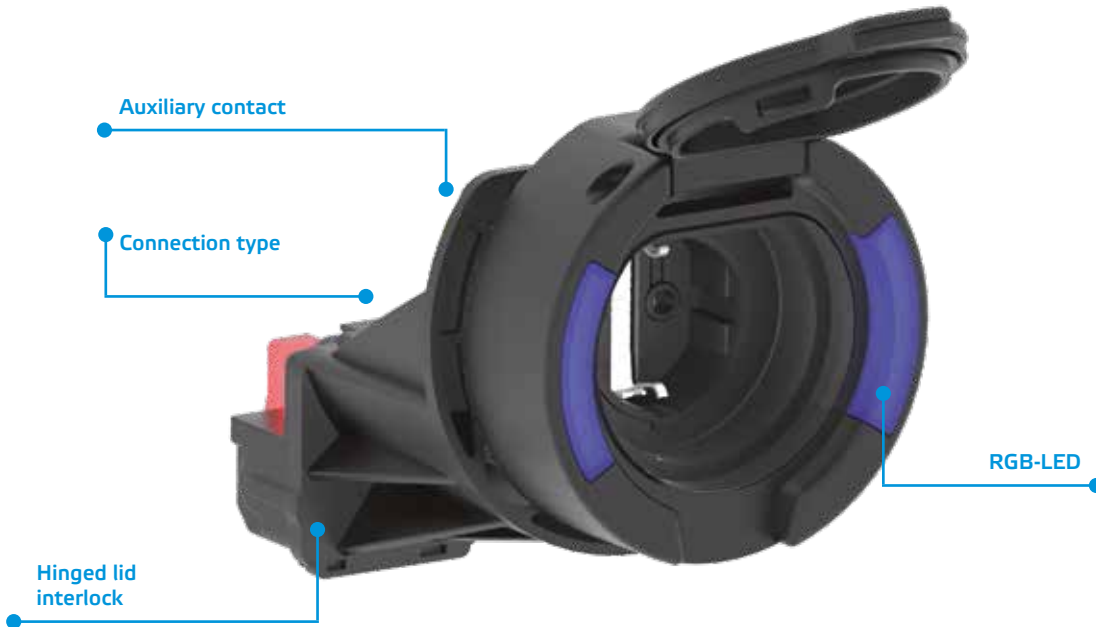

Connection type

Contact terminal designed as 16A continuous load suitable screw contact.



Auxiliary contact

Available in 2 versions:  
 - with auxiliary contact no (normally open) as standard version  
 - with auxiliary contact nc (normally closed) on request



Hinged lid interlock

Available with or without hinged lid lock.

The charging socket is protected by the built-in hinged lid interlock, e.g. from access by unauthorized users.

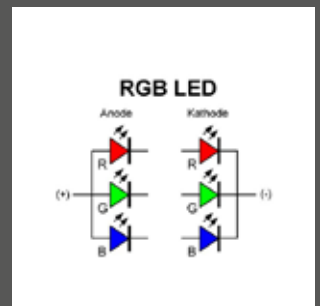

RGB-LED

2x RGB-LED lighting available in two versions:  
 - as standard version with common anode (+)  
 - on request as version with common cathode (-)

Type	Hinged lid interlock	RGB-LED	Part No.
Type F (german)	<input type="checkbox"/>	<input type="checkbox"/>	E-801941-01
Type E (belg. /french)	<input type="checkbox"/>	<input type="checkbox"/>	E-801942-01
Type F (german)	<input checked="" type="checkbox"/>	<input type="checkbox"/>	E-801921-01
Type E (belg. /french)	<input checked="" type="checkbox"/>	<input type="checkbox"/>	E-801922-01
Type F (german)	<input type="checkbox"/>	<input checked="" type="checkbox"/>	E-801951-01
Type E (belg. /french)	<input type="checkbox"/>	<input checked="" type="checkbox"/>	E-801952-01
Type F (german)	<input checked="" type="checkbox"/>	<input checked="" type="checkbox"/>	E-801931-01
Type E (belg. /french)	<input checked="" type="checkbox"/>	<input checked="" type="checkbox"/>	E-801932-01



## Schuko-type charging socket 16A 230V - IP20

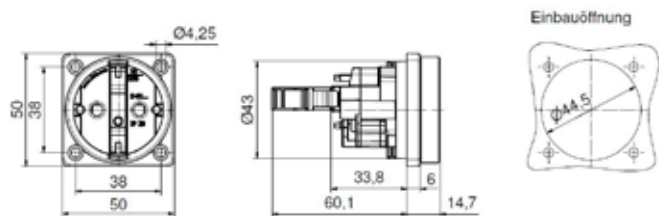
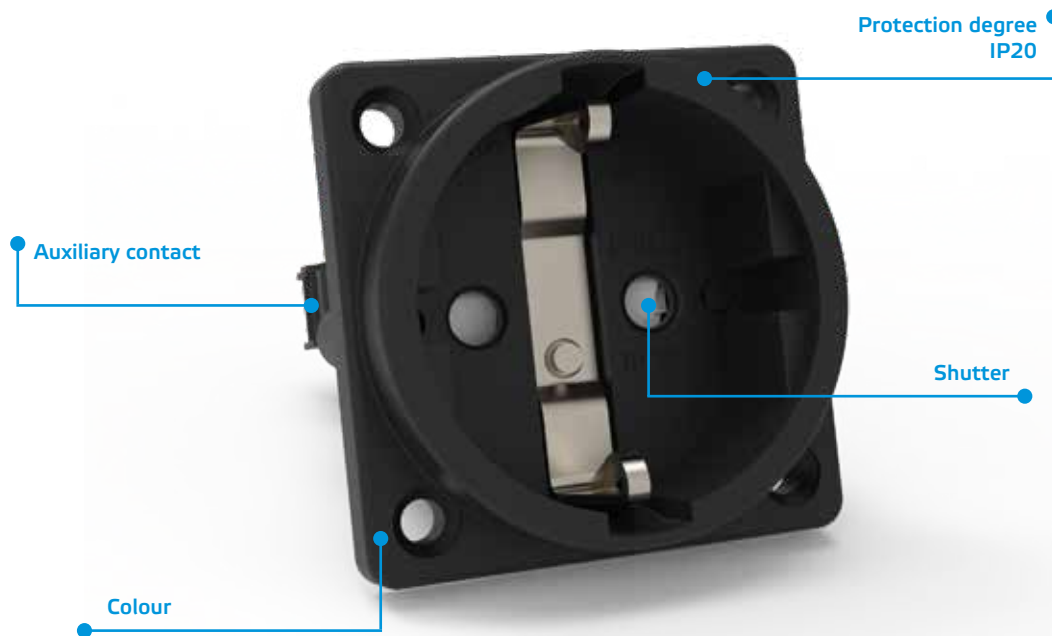

General

- Protection degree IP20
- Flange: 50 x 50 mm
- with Shutter function



Colour

Various color options available.



Connection type

Contact terminal designed as silver-plated 16A continuous load suitable screw contact.



Auxiliary contact

- Available in 2 versions:
- with auxiliary contact no (normally open) as standard version
  - with auxiliary contact nc (normally closed) on request
  - with auxiliary contact co (changeover contact) on request

Type	Colour	With Auxiliary contact "normally closed"	Part No.
Type F (german)	blue	■	E-8108A
Type E (belg. /french)	green	■	E-8109A
Type F (german)	black	■	E-8110A
Type E (belg. /french)	blue	■	E-8208A
Type F (german)	green	■	E-8209A
Type E (belg. /french)	black	■	E-8210A
Type F (german)	blue	□	E-8114
Type E (belg. /french)	green	□	E-8115
Type F (german)	black	□	E-8116
Type E (belg. /french)	blue	□	E-8214
Type F (german)	green	□	E-8215
Type E (belg. /french)	black	□	E-8216



## Schuko-type charging socket 16A 230V - IP54

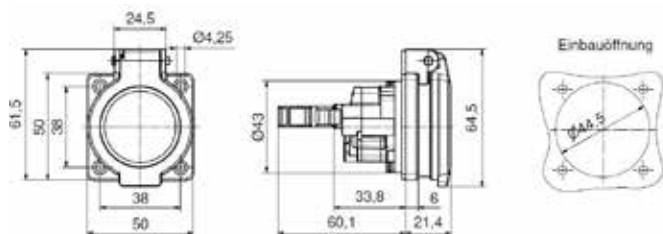
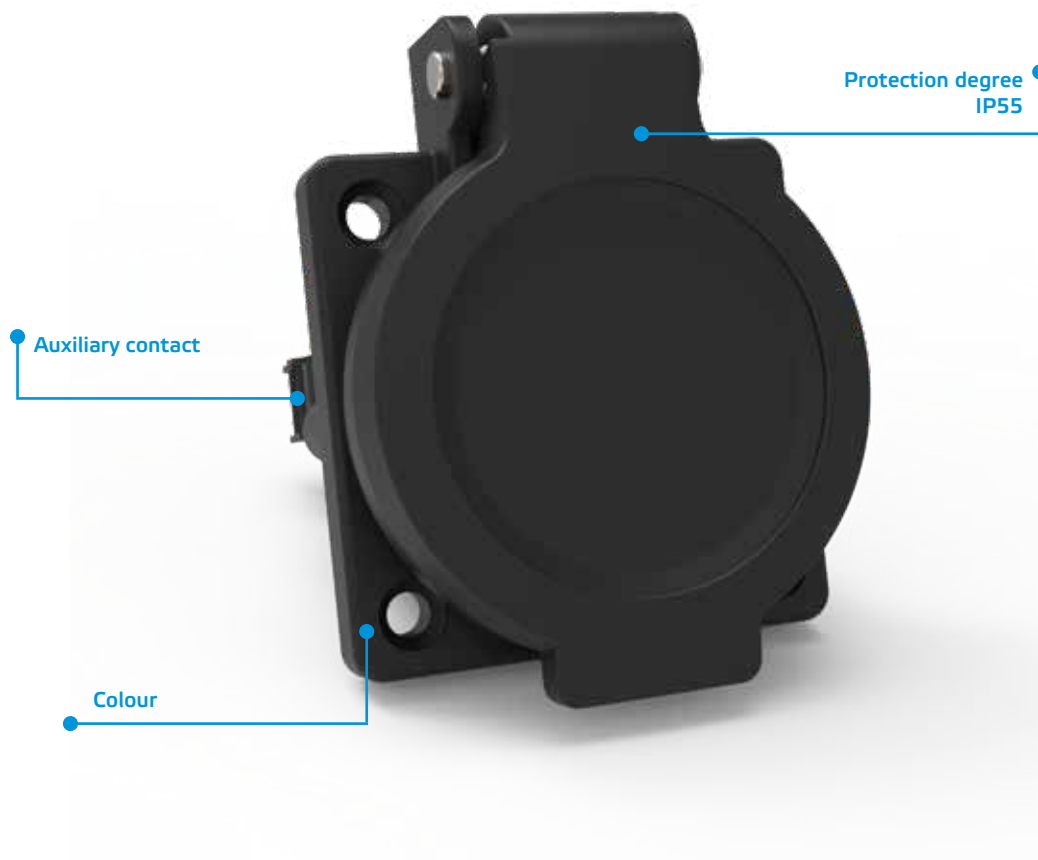

General

- Protection degree IP54
- Flange: 50 x 50 mm
- with Shutter function



Colour

Various color options available.



Connection type

Contact terminal designed as silver-plated 16A continuous load suitable screw contact.



Auxiliary contact

- Available in 2 versions:
- with auxiliary contact no (normally open) as standard version
  - with auxiliary contact nc (normally closed) on request
  - with auxiliary contact co (changeover contact) on request



Type	Colour	With Auxiliary contact "normally closed"	Part No.
Type F (german)	blue	■	E-8101A
Type E (belg. /french)	green	■	E-8102A
Type F (german)	black	■	E-8103A
Type E (belg. /french)	blue	■	E-8201A
Type F (german)	green	■	E-8202A
Type E (belg. /french)	black	■	E-8203A
Type F (german)	blue	□	E-8107
Type E (belg. /french)	green	□	E-8108
Type F (german)	black	□	E-8109
Type E (belg. /french)	blue	□	E-8207
Type F (german)	green	□	E-8208
Type E (belg. /french)	black	□	E-8209



Connection cable for 3pin actuators - E-314-1000



General

The E-314-1000 connection cable is equipped as standard with a Hirschmann connector and 1000 mm long single wires with smoothly cut ends.



Use

The E-314-1000 connecting cable is required for connecting the 3-pole plug locking actuator and the hinged lid locking actuator.



Confection

Different wire lengths and confection possible on request.



## EVCS 2 tester

The EVCS 2 tester is an easy-to-handle device that can simulate the basic charging states at a charging station with a type 2 charging socket. With the compact tester, you can ensure that the charging station is always functional – and continues to be so. You can easily simulate various coding resistances of the charging cable, changes in charge status or errors. The integrated BNC measuring output allows you to easily visualise the CP PWM signal, e.g., on an oscilloscope.

### Features

- The EVCS 2 tester includes the following functions
- Specification of the charging cable coding for simulating the maximum charging current
  - Test of the PE connection between PWM and vehicle plug
  - Simulation of an interruption of the PE protective conductor
  - Simulation of the vehicle states
  - Display of the PWM signal (CP measurement socket)
  - Phase sequence indicator L1, L2, L3
  - Rotary field indicator
  - Test sockets (simulation of external leakage currents)
  - Dimensions H x W x D: 205 x 105 x 40 mm
  - Plastic housing with rubber-coated sides
  - Plug: type 2 charging plug with 1 m connection cable
  - Colour: green/ black

Part No. E-994

Optional  
- With type 3 version Part No. E-996

 made  
 in  
 Germany



Simply. Well. Connected.

Bals Elektrotechnik GmbH & Co. KG  
D-57399 Kirchhundem-Albaum  
Phone: +49 27 23/771-0  
Fax: +49 27 23/771-177/178  
E-mail: [info@bals.com](mailto:info@bals.com)  
Internet: [www.emobile-bals.com](http://www.emobile-bals.com)

Subject to technical modifications and typographical errors